



FTX-S1XG-B23Y-040D

XFP 10Gbps, BiDi, 1270/1330nm, single-mode, 40km



Description

FTX-S1XG-B23Y-040D series XFP transceiver can be used to setup a reliable, high speed serial data link over single-mode fiber. Maximum link span can reach 40km. This transceiver is based on WDM (BiDi) technology thus it is possible to send (TX:1270nm) and receive (RX:1330nm) data simultaneously in both directions over single strain of fiber. To establish working connection this transceiver should be matched with companion module (FTX-S1XG-B32Y-040D). Device is fully compliant with XFP MSA specifications and it is available in four hardware versions

Model	Operating case temperature
FTX-S1XG-B23Y-040D	0~70°C
FTX-S1XG-B23Y-040DI	-40~85°C

Host device can access module internal EEPROM memory and DDMI via I²C interface.

Built-in digital diagnostic interface (DOM, DDMI) allows a network administrator to monitor module parameters such as: transmitted and received optical power, temperature, supply voltage and laser current. Those information and data are very helpful e.g. in prediction and prevention of connection failures. A module is available in various dedicated versions, which can be compatible with devices from vendors such as Cisco, HP, Juniper, Extreme Networks, Alcatel-Lucent, 3Com, Linksys and more.

Applications

- 10G Ethernet
- Fiber Channel (10G FC)
- SONET/SDH (OC-192/STM64)



Key features

- LC Simplex receptacle
- Transmission distance up to 40km*
- DFB laser diode (1270nm) transmitter, PIN photodiode receiver (1330nm)
- Throughput up to 11.3Gb/s
- Fully compliant with XFP MSA INF-8077i and INF-8472 rev. 11.3
- Hot-Pluggable
- RoHS compliant
- Class 1 laser safety
- Low power dissipation (<1W)
- Metal case for low EMI
- Operating case temperature* : 0~70°C / -40~85°C

Specification

Supported transmission technology

10G Ethernet, Fibre Channel

Speed supported for Ethernet technology

10.25Gbps, 1.25Gbps

Speed supported for Fibre Channel technology

10.51875Gbps

Transmission medium

Single-mode fiber 9/125µm

Transmission distance**

40km

Receptacle type

LC Simplex

Wavelength

1270/1330nm

Output power

-1~+4dBm

Receiver sensitivity

-16dBm

Power supply voltage

3.3V

Total power consumption

< 1W

Operating environment – temperature*

0~70°C / -40~+85°C

Operating environment - humidity

5~95% non-condensing

Dimensions

Compliant with XFP Multi-Source Agreement

* - standard / industrial version

** - transmission distance depends on optical link attenuation



Detailed technical specification

Pin Description

Pin	Name	Function/Description	Logic	Notes
1	GND	Module Ground		1
2	V _{EE5}	Optional -5.2V Power Supply - Not Required		-
3	Mod_DeSel	Module De-select; When held low allows module to respond to 2-wire serial interface	LVTTTL-I	-
4	Interrupt	Interrupt; Indicates presence of an important condition	LVTTTL-0	2
5	TX_DIS	Transmitter Disable; Turns off transmitter laser output	LVTTTL-I	-
6	V _{CC5}	+5V Power Supply - Not Required		-
7	GND	Module Ground		1
8	V _{CC3}	+3.3V Power Supply		-
9	V _{CC3}	+3.3V Power Supply		-
10	SCL	2-Wire Serial Interface Clock	LVTTTL-I/O	2
11	SDA	2-Wire Serial Interface Data Line	LVTTTL-I/O	2
12	Mod_Abs	Indicates Module is not present. Grounded in the Module	LVTTTL-0	2
13	Mod_NR	Module Not Ready; Indicating Module Operational Fault	LVTTTL-0	2
14	RX_LOS	Receiver Loss Of Signal Indicator	LVTTTL-0	2
15	GND	Module Ground		1
16	GND	Module Ground		1
17	RD-	Receiver Inverted Data Output	CML-0	-
18	RD+	Receiver Non-Inverted Data Output	CML-0	-
19	GND	Module Ground		1
20	V _{CC2}	+1.8V Power Supply - Not Required		-
21	P_Down/RST	Power down; When high, requires the module to limit power consumption to 1.5W or below. 2-Wire serial interface must be functional in the low power mode. Reset; The falling edge initiates a complete reset of the module including the 2-wire serial interface, equivalent to a power cycle.	LVTTTL-I	-
22	V _{CC2}	+1.8V Power Supply - Not Required		-
23	GND	Module Ground		1
24	RefCLK+	Reference Clock Non-Inverted Input, AC coupled on the host board - Not Required	PECL-I	3
25	RefCLK-	Reference Clock Inverted Input, AC coupled on the host board - Not Required	PECL-I	3
26	GND	Module Ground		1
27	GND	Module Ground		1
28	TD-	Transmitter Inverted Data Input	CML-1	-
29	TD+	Transmitter Non-Inverted Data Input	CML-1	-
30	GND	Module Ground		1

Notes:

1. Module ground pins GND are isolated from the module case.
2. Shall be pulled up with 4.7KΩ to 10KΩ to a voltage between 3.15V and 3.45V on the host board.
3. Reference Clock is not required. If present, it will be ignored.



Electrical parameters

Parameter	Symbol	Min.	Typ.	Max.	Unit	Notes
Transmitter Differential Input Volt	+/-TX_DAT	120		1000	mV p-p	1
Receiver Differential Output Volt	+/-RX_DAT	400		800	mV p-p	2
Tx_Disable, P_Down/RST	Input Voltage – Low	V _{IL}	0	0.8	V	
	Input Voltage - High	V _{IH}	2.0	V _{CC}	V	
RX_LOS, Mod_NR, Interrupt	Output Voltage – Low	V _{OL}	0	0.8	V	3
	Output Voltage - High	V _{OH}	2.0	V _{CC}	V	3
Throughput	B			11.3	Gb/s	
Total current requirement				600	mA	3.3V
				450	mA	5V

Transmitter parameters

Parameter	Symbol	Min.	Typ.	Max.	Unit	Notes
Central wavelength	λ_c	1260	1270	1280	nm	
Spectral width	$\Delta\lambda$			1	nm	
Launch optical power	P _o	-1		+4	dBm	4
Extinction ratio	EX	4			dB	
Dispersion penalty				1	dB	
Optical Return Loss Tolerance	ORLT	14			dB	
Optical rise/fall time	T _{rise} /T _{fall}			30	ps	5
Eye diagram	Compliant with IEEE802.3-2005 10Gbps					

Receiver parameters

Parameter	Symbol	Min.	Typ.	Max.	Unit	Notes
Sensitivity	P _{min}			-16	dBm	6
Stressed Sensitivity (OMA)				-14	dBm	
Central wavelength	λ_c	1320		1340	nm	
Receiver overload	P _{MAX}	0			dBm	6
RX_LOS Asserted	S _A	-30			dBm	
RX_LOS De-Asserted	S _D			-17	dBm	
RX_LOS Hysteresis	-		3.0		dB	

Notes:

- Internally AC coupled and terminated to 100Ω differential load.
- Internally AC coupled, but requires a 100Ω differential termination or internal to Serializer/Deserializer.
- It is open collector/drain output which should be pulled up externally to V_{CC} with a 4.7KΩ-10KΩ resistor on the host board. LOS: logic 0 indicates normal operation; logic 1 indicates no signal detected.
- Optical power is launched into SMF
- 20-80%
- Measured with PRBS 2³¹-1 at test pattern @10.3125Gbps.



Mechanical specification

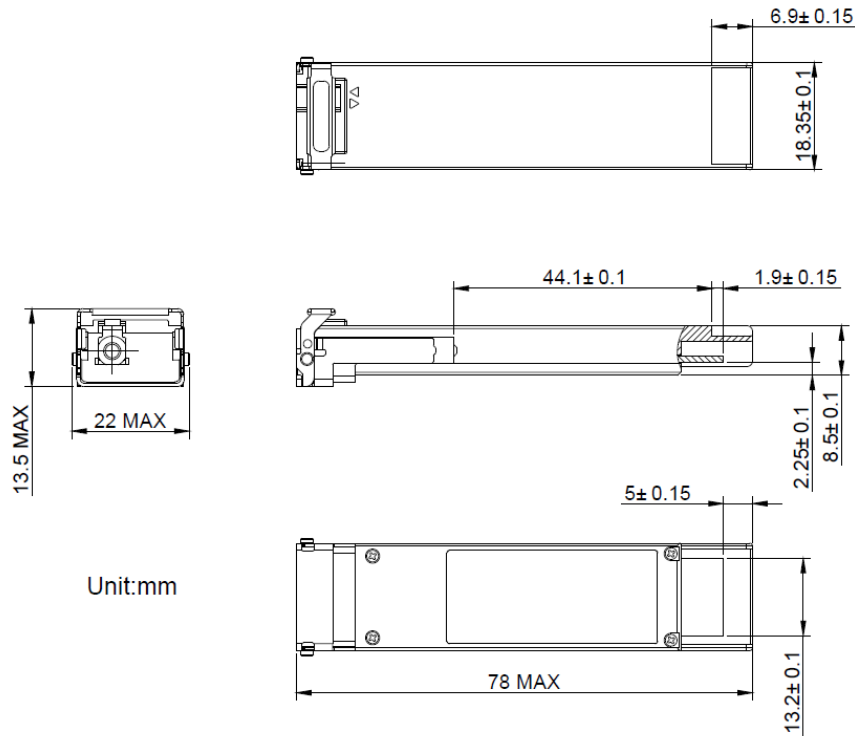

Recommended environment conditions

Parameter	Symbol	Min	Typ	Max	Unit
Operating Temperature Range (industrial)	T	-40	-	85	°C
Operating Temperature Range (standard)	T	0	25	70	°C
Supply Voltage	V _{CC}	3.135	3.3	3.465	V
Relative Humidity	RH	5	-	95	%

Ordering information

FTX-S1XG-B23Y-040D – 1270/1330nm, 40km, single-mode, LC simplex, **DDMI**, commercial temperature (0~70°C)

FTX-S1XG-B23Y-040DI – 1270/1330nm, 40km, single-mode, LC simplex, **DDMI, extended temperature** (-40~85°C)

For further information regarding host device PCB layout recommendation, power supply requirements, EEPROM memory map, DDMI specification please check:

[SFF-8472 - Description of EEPROM and Digital Diagnostic Monitoring Interface](#) and [INF-8077i - Technical specification for XFP transceiver](#)

Fibrain Sp. z o.o. reserves the right to make changes to the products or information contained herein without notice. No liability is assumed as a result of their use or application.

Pictures used for reference only, actual product look may differ. For most actual information please contact technical support via aktywa@fibrain.pl